

## Field-proven Edge Connectivity to Bring Your Field Data to OT/IT Systems



Serial Device Servers



Media Converters



Protocol Gateways



USB-to-serial Converters/USB Hubs



Multiport Serial Boards



Remote I/Os

# Things You Need to Know to Effectively Transfer Field Data to IT/OT Systems

**G**etting insights from data sources for more precise decision making is at the heart of most industrial automation applications. To achieve this goal, businesses need to make their field data accessible to information technology (IT) and operational technology (OT) systems. Discover how Moxa's ready-to-connect, ready-to-secure, and ready-to-adapt edge connectivity solutions can help your industrial applications.

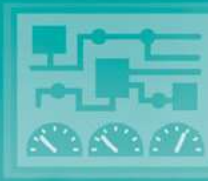

**IT/OT Systems**

**Versatile, Comprehensive Portfolio**

**Ready to Connect**

**Security-hardened Device Security**

**Ready to Secure**

**Industrial Edge Connectivity Solutions**

**Pioneering Reliability With 35+ Years of Field-proven Experience**

**Ready to Adapt**



# What's Inside

## Field-proven Edge Connectivity

- Ready-to-connect Edge Connectivity 3
- Ready-to-secure Device Security 5
- Ready to Adapt to New Market Demands 7

## Applications

- Reliable and Scalable Ways to Read the Room 9
- Realize Your Machine Potential With Machine Data Collection 11

## Quick Product Selection

- Serial Device Servers 13
- Media Converters 15
- Protocol Gateways 16
- USB-to-serial Converters/USB Hubs 17
- Multiport Serial Boards 17
- Remote I/Os 18



Ready-to-connect Edge Connectivity

# Connect Your Edge Devices and Covert Communication at Once



Do you know you can easily connect all your edge devices, enabling communication right away with no hassles? Find out how our ready-to-connect edge connectivity can help.

According to the latest market report, the market share of fieldbuses has renewed strength in 2022 while industrial Ethernet continues to grow. This signifies that factories favor installed and proven industrial network solutions during uncertain times. How do you meet these wide demands for edge connectivity? Check out our versatile product portfolios.

## Serial-to-Ethernet

Moxa's field-proven serial device servers have been reliably connecting your serial devices to Ethernet networks or Wi-Fi networks in multiple harsh environments for decades.

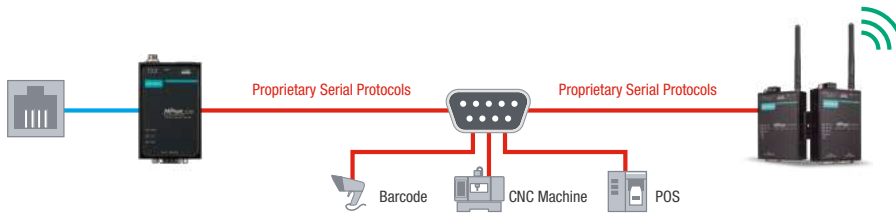

**Need to Extend Ethernet Connection?**  
Moxa offers industrial media converters that provide copper-to-fiber, Gigabit-speed extensions in harsh conditions.

### Serial-to-USB

Our UPort series of USB-to-serial converters and hubs provide reliable and high-performance communication.



### Serial-to-fiber

Our industrial-grade serial-to-fiber optic converters provide an easy and reliable way to connect serial devices.

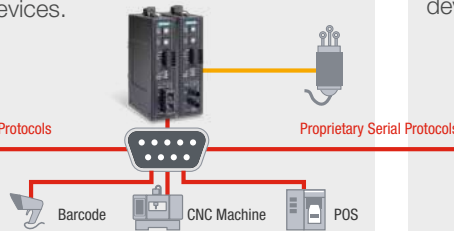

### Serial-to-IPC

Our multiport serial boards offer a wide array of slot variations to connect your IPCs with serial devices.

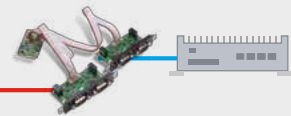

## Protocol Conversion

Our fieldbus-to-Ethernet protocol gateways connect and convert your edge communication.

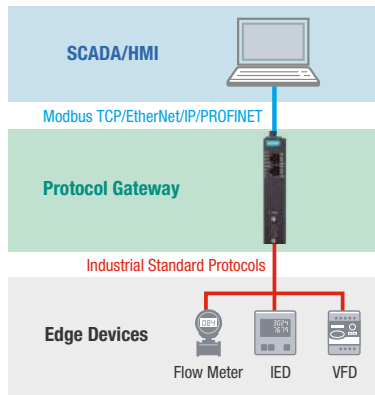

## I/O-to-Ethernet

We offer a series of remote I/Os for retrieving your I/O data to either SCADA, HMI or database.

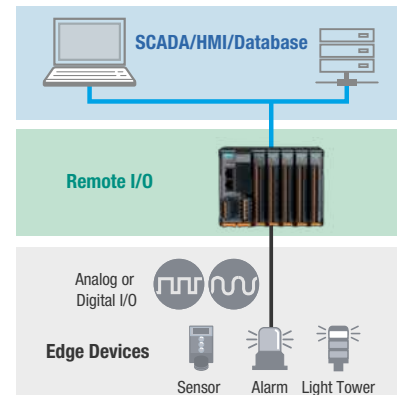

## What's New



► **ICF-1171 Series**  
Industrial CAN-to-fiber converters



► **CSM-G200 Series**  
Ethernet-to-fiber media converters



► **UPort 200A/400A Series**  
Industrial USB 3.2 hubs

# Want to Securely Collect Your Field Data?

As cyberthreats pose an ever-present danger to industrial applications, Moxa's tips aim to help you mitigate vulnerabilities and risks

Is your industrial field data secure? This question arises because digitalization has sped up the development of the industrial control system landscape in recent years. Originally, industrial control systems were physically isolated and almost immune to cyberattacks. However, a recent rise in the number and types of cyberattacks has spurred IT and OT teams into action to thwart these threats.

Commonly, **industrial control systems (ICS)** comprise three layers: **field, control, and management**. In recent years, collecting data from field layers has become more complex, as they perform more automation processes, meaning that the data at the edge is critical for control and monitoring. For this reason, it is very important to secure data at the edge of an ICS.



## The threats you need to look out for

Although your ICS may be physically isolated and not directly connected to the Internet, according to market research\*, ICS might encounter these common cyberthreats:

1

### Sophisticated Cyberattacks

Sophisticated cyberattacks, such as Stuxnet and Industroyer, targeting ICS networks since 2010.

2

### Unintentional Cyberattacks

You don't have to be a direct target to become a victim of a cyberattack. About 80% of industrial security incidents are unintentional.

3

### Unsecure Connections

Physically isolated ICS may still have unsecure connections, such as maintenance from third-party vendors.

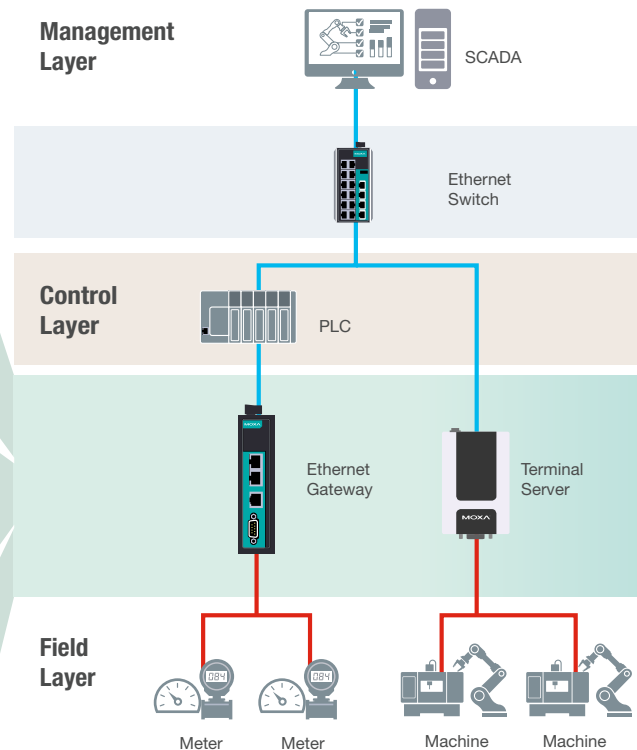

\*Source: SANS Institute <https://www.sans.org/>



### Four tips to ensure your data is secure at the edge

Understanding industrial cybersecurity requirements helps companies mitigate risks to their systems. Following these four tips closely will help you strengthen cybersecurity to lower the risks to your network:



#### #1 | User Authentication

Verify user identification when logging in to a device

#### #2 | Network Access Control and Authentication

Verify which devices are permitted to access the network and communicate with other devices

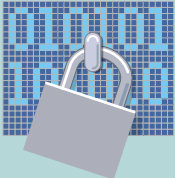

#### #3 | Data Integrity and Confidentiality

Encrypt the connections to devices for configuration and management

#### #4 | Vulnerability Management

A well-defined process for device suppliers to respond to reported vulnerabilities



## We Recommend

Moxa's expertise in industrial connectivity helps customers connect their devices securely via:

- Secured remote access with **HTTPS** and **SSH**
- Encrypted data transmission with **Secure Real COM** and **Secure TCP Server/Client** modes
- A proactive approach to **security vulnerabilities**



▶ **NPort 6100/6200 Series**  
1/2-port RS-232/422/  
485 secure terminal  
servers

▶ **NPort 6400/6600 Series**  
4/8/16/32-port RS-232/422/485  
secure terminal servers



▶ **MGate 5134/5135/  
5435 Series**  
Secure protocol gateways



To learn more about Moxa's complete industrial network security portfolio, visit: [www.moxa.com/security](http://www.moxa.com/security)



Adapt to

# New Market Demands

Are your edge connectivity ready to adapt to the ever-changing market trends? Granting your business a new competitive advantage to thrive is key.

## *At the Edge of Change:*

### **Industrial Automation Systems Are Evolving**

Industrial automation systems have been operating for decades to improve the quality of human life. As new technologies develop, industrial automation also adopts new systems to enable more efficient production. These new systems evolve to become more compact to save space in the field. Because of this trend, industrial engineers face the challenge of connecting serial devices to new systems. Since 1987, Moxa has been providing multiport serial boards and keeps updating the drives for different OS platforms to help speed up the serial connectivity in customers' field sites.

## **What's New**



▶ **CP-102N Series**  
Mini PCIe Boards

## At the Edge of Change:

### OT/IT Systems Are Converging

According to an IT/OT convergence report released by IoT Analytics, integrating IT and OT tools is one of the top trends in automation. As digital transformation cannot solely rely on one side, collecting OT data and efficiently aggregating it to IT for analysis is critical. Anticipating this trend, Moxa has developed its next-generation MGate Series to support higher throughput, reliable connectivity, and emerging industrial protocols to significantly reduce the integration effort for both OT and IT engineers.

### Introducing Moxa's Next-generation MGate Series Protocol Gateways



#### Support Mainstream & Emerging Industrial Protocols

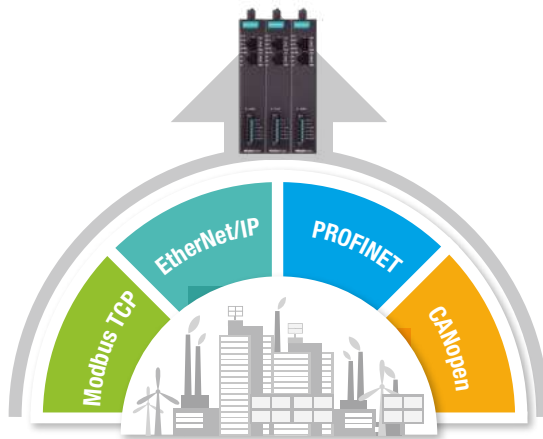

Higher Throughput



Reliable and Security Connectivity



Robust Firmware Updates



#### Efficiently Integrating to Both OT/IT Systems

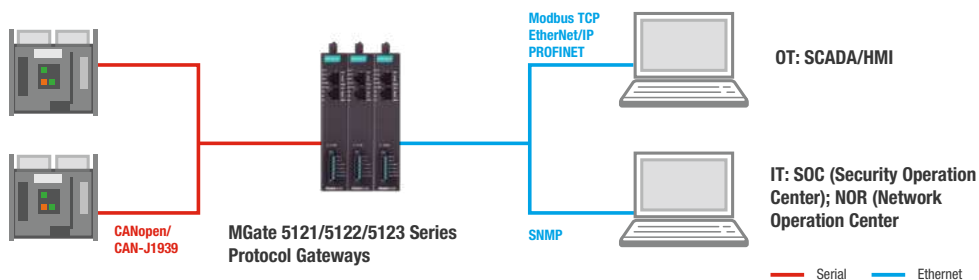

## What's New



▶ MGate 5134 Series Industrial Modbus RTU/ASCII/TCP-to-PROFINET gateways



▶ MGate 5135/5435 Series Industrial Modbus RTU/ASCII/TCP-to-EtherNet/IP gateways



▶ MGate 5121/5122/ 5123 Series Industrial CANopen/CAN-J1939 to Modbus TCP/EtherNet/IP/PROFINET and SNMP gateways

\*Available in Q3 2023

# Reliable and Scalable Ways to Read the Room

## Industrial-grade connectivity solutions for facility management

**F**acility management is crucial for ensuring environmental comfort and operational efficiency, such as power management and heating, ventilation, and air conditioning (HVAC) in data centers, hospitals, or factories. To ensure smooth facility management, reliable system connectivity is always essential. Another consideration is that when there is a need to add capacity, the facility management system should be able to scale up in the least amount of time. Choosing connectivity devices that support scalable deployment is key.

### Reliable Connectivity

To ensure high availability and data protection, Moxa's protocol gateways and remote I/Os feature:

- Industrial-grade design: high **EMC protection** up to level 3, **serial isolation** protection, and **-40 to 75°C** wide-temperature operability
- A **5-year warranty** for longer service support
- Enhanced cybersecurity functions, including **HTTPs** and **SNMPv3** for configuration and management

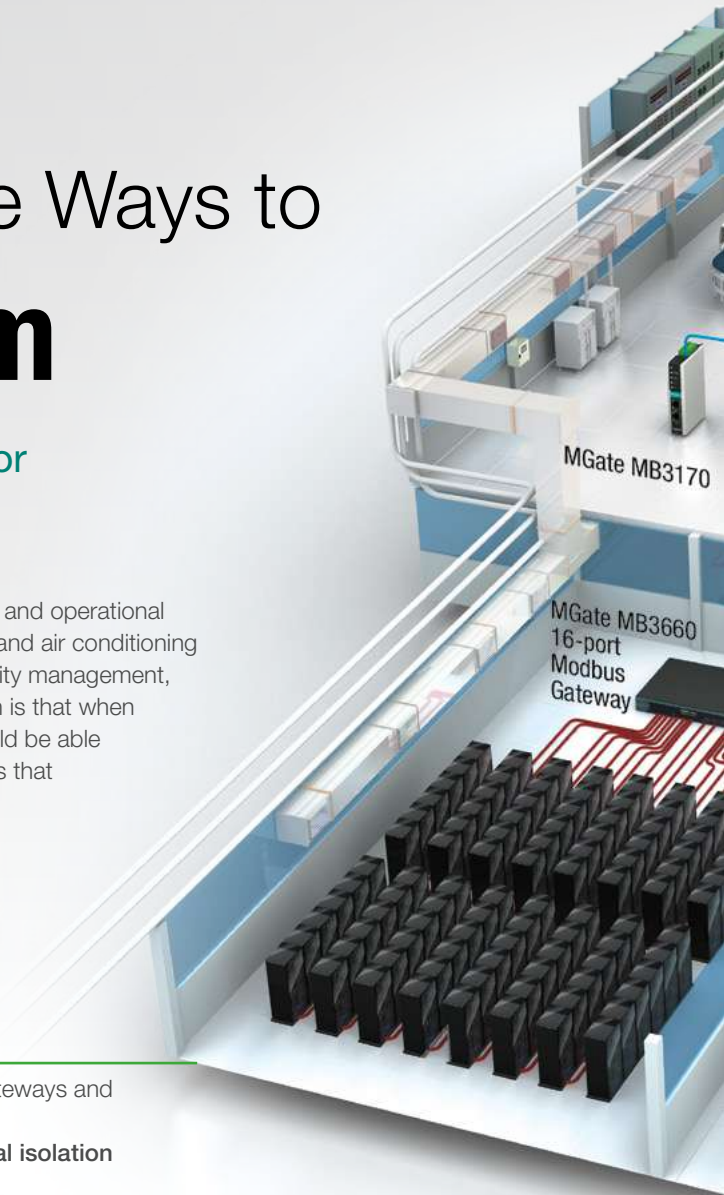

### Example 1 | Environmental Monitoring for Data Centers

A facility management system integrator (SI) helped a data center owner build an IT-based environmental monitoring system. The system required **large-scale deployment** as it was looking towards expansion in the future.

#### The Solution:

The SI selected Moxa's **ioLogik E1200 remote I/O** to monitor light, humidity, and temperature sensors. The **SNMP** protocol support made it easy to integrate with the facility management software system. Featuring a built-in 2-port switch, it also supported **daisy-chain** network topology for flexible deployment.

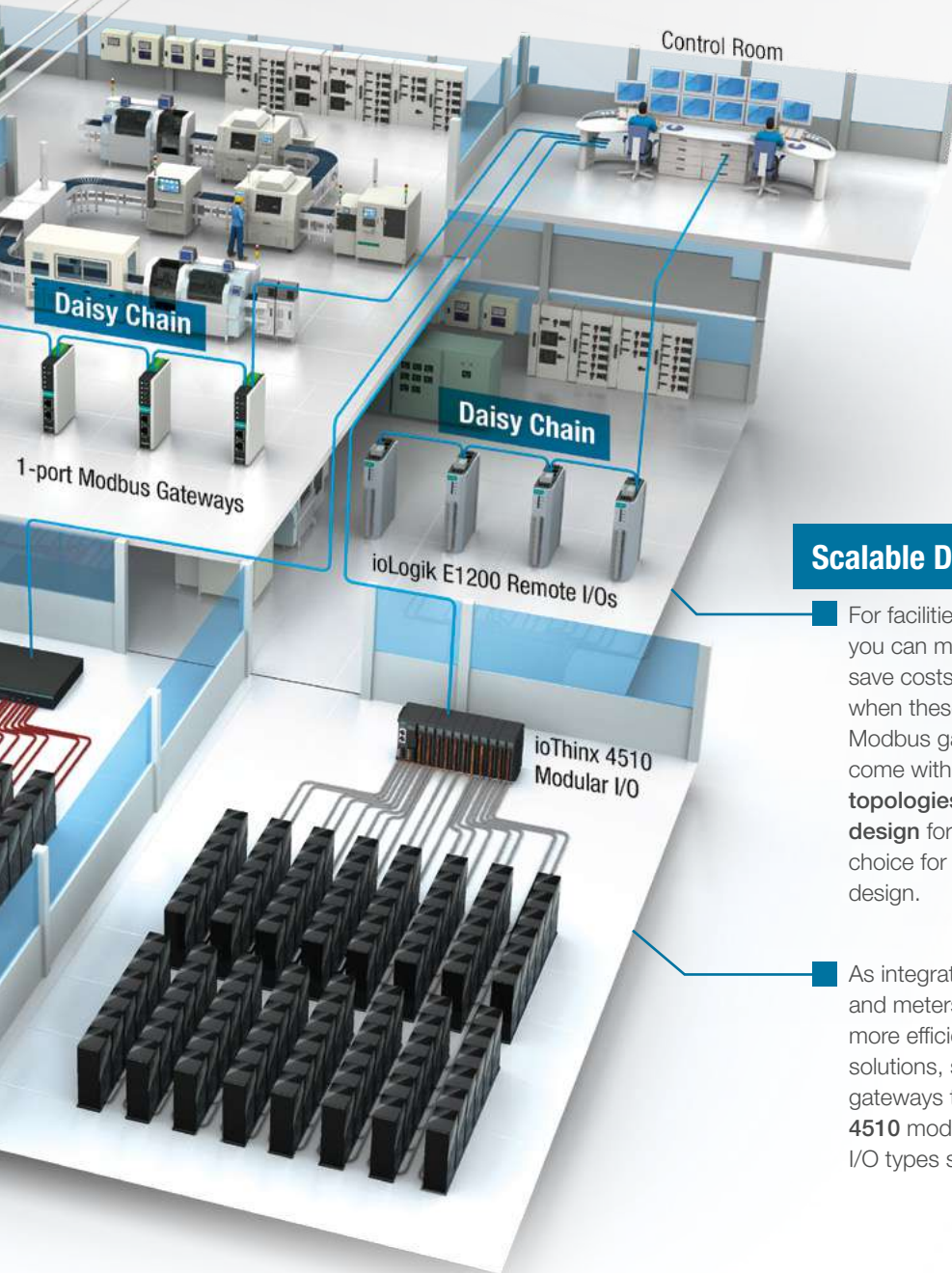

### Scalable Deployment

For facilities distributed over a large or different floor, you can make use of daisy-chain Ethernet topology to save costs, and it's easy to add additional connections when these facilities expand. Moxa's **MGate MB3170** Modbus gateways and **ioLogik E1200** remote I/Os come with dual Ethernet switches for **daisy-chain topologies**. They also feature a **compact-sized design** for easy installations, making them the ideal choice for future-proof facility management system design.

As integrated facilities contain a numerous sensors and meters in one room, such as a data center, it's more efficient to choose high-port density connectivity solutions, such as Moxa's **MGate MB3660** Modbus gateways that support up to 16 serial ports or **ioThinX 4510** modular I/Os that support **32 slots** with different I/O types such as **DIO, AIO, RTD, and TC**.



### Example 2 | Power Monitoring for Data Centers

To develop its own billing system, a colocation service provider needed to connect thousands of serial-based Modbus RTU meters to its Modbus TCP network for power measurement, and the system had to support **redundancy** to ensure system reliability.

#### The Solution:

The service provider chose Moxa's **MGate MB3660 16-port Modbus gateways** for their **high-port density** and long MTBF. The gateways support dual Ethernet connections with dual IP address for **network redundancy** and dual AC power input for **power redundancy**.



Scan the QR code to read more case studies



Case in Point

# Realize Your Machine Potential With Machine Data Collection

Every second a machine in a factory is idling, offline, or shut down for maintenance, it translates into a loss of profit. Thus, the efficiency of machines matters to the bottom line of automated machines. To improve productivity, factory managers need real-time information about the status of their machines.

Usually, the goal is to shape your machine data collection strategy. Through numerous examples, Moxa has demonstrated its expertise by providing reliable, easy-to-deploy connectivity solutions to system integrators and machine builders to develop their machine data collection applications.

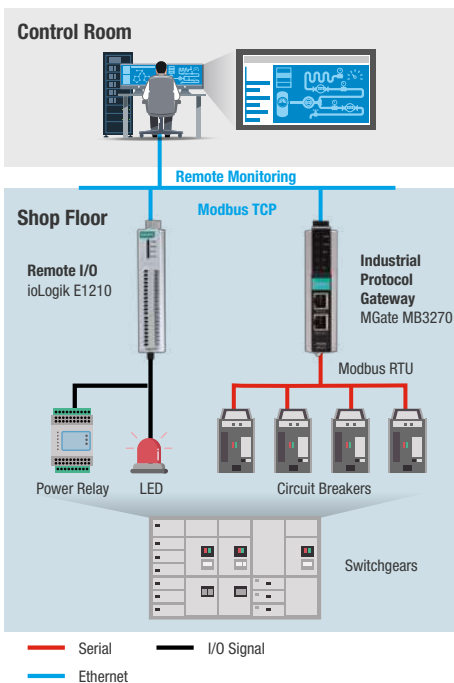

## Example 1 | Remote Access for ATS Control

A system integrator is developing automated transfer switches for its customers to enable remote monitoring of the AC power stability. To access data collected in switchgears, it is essential to build reliable communication between devices installed in there. Furthermore, its customer requests the entire system to comply with the customer's cybersecurity policy. The solution required transferring data remotely and securely.

### The Solution:

Moxa's MGate MB3170/MB3270 Series industrial protocol gateways were chosen for:

- Transparent protocol conversion from Modbus RTU to Modbus TCP
- Easy-to-use interface for configuration
- Troubleshooting tool to for diagnosis when needed

Moxa's ioLogik E1210 Series remote I/Os were chosen for the digital input data collection. Both the MGate and ioLogik Series feature high reliability to work even in harsh environments.

Last, but not least, Moxa provided security questionnaires and hardening guide services to this customer to meet the cybersecurity requirements.

## Example 2 | Low-latency Connectivity for Semiconductor Equipment Systems

A semiconductor equipment system builder was looking for a serial-to-Ethernet solution that would allow operators to retrieve the running parameters from built-in serial devices inside the system on the shop floor. Each system is comprised of several wafer processing chambers integrated in high-vacuum conditions.

### The Solution:

Our NPort Series was deployed to connect the critical components at the device level in processing and wafer transfer modules in the semiconductor equipment system from the remote computers in the remote site.

Moxa's NPort 5650-8-DT and NPort 5650-8 Series serial device servers were chosen for:

- 8 serial ports to Ethernet networks
- Efficient deployment by leveraging the Real COM operation mode and WinCE drivers
- Low latency with FIFO adjustment and transmission modes
- High product reliability even in harsh environments

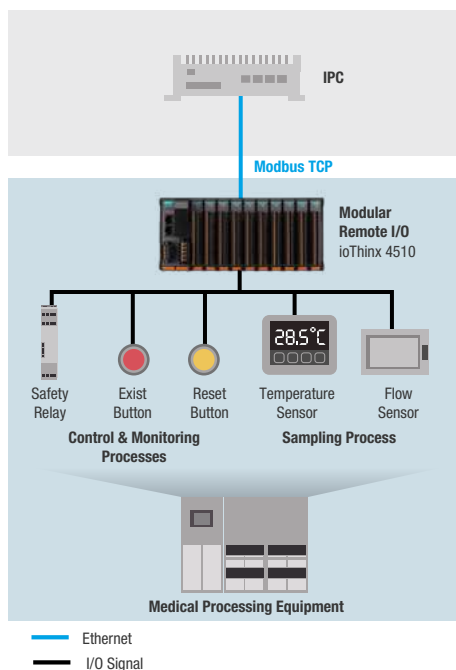
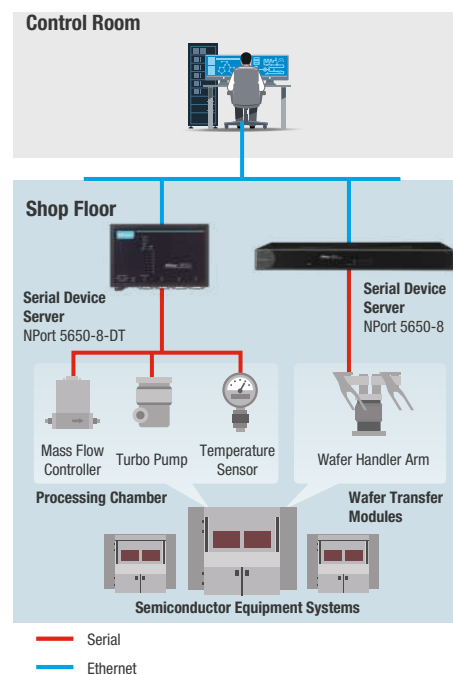

## Example 3 | Monitoring of Medical Processing Equipment

A medical equipment builder was developed a high-speed and ultra-high throughput medical processing equipment. Because of the increasing demands for medical processing, medical equipment builders sought connectivity solutions that were flexible enough to meet the needs of regular updates on its medical equipment.

### The Solution:

Moxa's ioThinX 4510 series of advanced modular remote I/Os perfectly fulfill the system requirements, allowing the customer to select the I/O combination that best fits the application—to connect devices such as flow sensors and temperature sensors in the sampling process, and connect devices such as safety relays, reset buttons, and exist buttons in the control and monitoring processes.

### The ioThinX 4510 Series features:

- Multiple modules available with DI/Os, AIs, relays, RTDs, and other I/O types
- Its unique mechanical design, allowing installing and removing hardware with no tools needed
- Moxa Utility for configuration and auto-reconfiguration for maintenance
- Support X-architecture as a plus for additional path to connect to IT system (i.e., data analysis)

# Choose a Serial Device Server

Moxa provides the best-in-class serial device servers for your industrial applications. Therefore, bringing serial-based legacy devices into an Ethernet-based network is easy.



### Your Trusted Serial Partner

We pledge to provide long-term availability of serial products and continuous driver support



### Intuitive User Interfaces

Intuitive user interfaces that simplify configuration and operation, making connectivity simple and easy



### Field-proven Quality

Field-proven quality that endures harsh environments for any industrial applications

## General and Industrial Device Servers



**Standard**  
General-purpose applications



**Standard**  
General-purpose applications



**Rugged Design**  
Harsh environments, industrial certifications



**Wireless**  
Connect to 802.11 a/b/g/n Wi-Fi networks

	Model	NPort 5100A/ 5200A/5400	NPort 5600	NPort IA5100A/ IA5200A/IA5400A	NPort W2150A-W4/ W2250A-W4
<b>Basic</b>	Serial Ports	1-4	8/16	1-4	1-2
	RS-232/422/485	•	•	•	•
	Ethernet	1	1	2	1
	Windows/Linux Driver	•	•	•	•
	MAC OS Driver/ Android API	•	•	•	•
<b>Security</b>	Login Authentication	Password Protection (length, character enforcement)	Password Protection (length, character enforcement)	Password Protection (length, character enforcement)	Password Protection (length, character enforcement)
	Console Management	• HTTPS • Unused services can be disabled	• HTTPS • Unused services can be disabled	• HTTPS • Unused services can be disabled	• HTTPS • Unused services can be disabled
	Network Access Control	Accessible IP List	Accessible IP List	Accessible IP List	Accessible IP List (For operation modes only)
<b>Reliability</b>	Industrial Certifications	-	-	C1D2, ATEX, IECEx	-
	Serial Isolation	•	•	•	-
	Wide Temperature	•	•	•	•



See the complete product line at [www.moxa.com/NPort](http://www.moxa.com/NPort)

## Secure Terminal Servers



	Model	NPort 6150	NPort 6250	NPort 6450	NPort 6610	NPort 6650
<b>Ethernet</b>	10/100BaseTX (RJ45)	1	1	1 (Up to 3 with Network Expansion Modules)	1 (Up to 3 with Network Expansion Modules)	1 (Up to 3 with Network Expansion Modules)
	100BaseFX (SC Connector)	-	1 Multi-mode or Single-mode (Model Specific)	(Up to 2 with Network Expansion Modules)	(Up to 2 with Network Expansion Modules)	(Up to 2 with Network Expansion Modules)
	IPv6 Support	•	•	•	•	•
<b>Serial</b>	Serial Standard	RS-232/422/485	RS-232/422/485	RS-232/422/485	RS-232	RS-232/422/485
	Serial Port	1	2	4	8/16/32	8/16/32
	Windows/Linux/Fixed TTY Drivers*	•	•	•	•	•
	MAC OS Driver/ Android API	•	•	•	•	•
<b>Security</b>	Secure Operation Mode	Reverse SSH, Secure Pair Connection, Secure Real COM, Secure TCP Client, Secure TCP Server				
	Login Authentication	Default password, support of RADIUS, TACACS, TACACS+ authentication servers				
	Console Management	HTTPS (TLSv1.2 and above, with public certificate import), SSH, SNMPv3				
	Access Control	Account Management, Accessible IP List				
	Data Confidentiality	Serial Data Encryption, Encrypted Configuration File				

\* List of supported OS:

Windows 11, Windows 10, Windows 8, Windows 7, Windows Vista, Windows XP, Windows 2000, Windows NT, Windows Server 2019, Windows Server 2012, Windows Server 2008, Windows Server 2003, Windows CE 5/6, Windows XP Embedded, Linux 6.x, Linux 5.x, Linux 4.x x86/x64, Linux 3.x x86/x64, Linux 2.6 x86/x64, Mac OSX, QNX 6, QNX 4

# Choose a Media Converter

Whether it's media conversions between different serial interfaces or extension requirements for long-distance communication, you can find your multiple media converters here

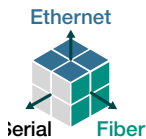

### A Wide Selection

Multiple solutions to enable network extensions for both serial and Ethernet interfaces through fiber networks



### Industrial-grade Reliability

Designed to endure wide operating temperatures and high EMI immunity, backed by industrial certifications



### Flexible Deployment

The plug-and-play and modular design makes our media converters easy to deploy in any application



**Basic**  
Entry level, plastic housing



**Standard**  
General purpose, aluminum housing



**Gigabit**  
High-bandwidth data, video applications



**Advanced**  
Harsh environment, industrial certifications



**Gigabit**  
High-bandwidth data, video applications



**Standard**  
General purpose, aluminum housing



**Advanced**  
Harsh environments industrial certifications



**CAN Bridge**  
CAN-to-fiber converters for distance extension



**Industrial**  
PROFIBUS-to-fiber converters

	Ethernet-to-fiber Converters					Serial-to-fiber Converters		Fieldbus-to-fiber Converters	
Model	IMC-21	IMC-21A	IMC-21GA	IMC-101	IMC-101G	TCF-142	ICF-1150	ICF-11711	ICF-1180I/1280I
Interface A	10/100 BaseTX (RJ45)	10/100 BaseTX (RJ45)	10/100/1000 BaseTX (RJ45)	10/100 BaseTX (RJ45)	10/100/1000 BaseTX (RJ45)	RS-232/422/485	RS-232/422/485	CAN/CAN FD	PROFIBUS DP (DB9 female)
Interface B	100 BaseFX	100 BaseFX	100/1000 BaseSX/LX, 100/1000 BaseSFP slot	100 BaseFX	1000 BaseSFP slot	100 BaseFX	100 BaseFX	100 BaseFX	100 BaseFX
Fiber Ring	-	-	-	-	-	•	•	-	-
Redundant Ring	-	-	-	-	-	-	-	-	Only for ICF-1280I
Port Alarm	-	-	-	•	•	-	-	-	-
Power Alarm	-	-	-	•	•	-	-	•	-
Serial Isolation	-	-	-	-	-	-	2 kV (1 model)	2 kV	0.5kV
Serial Surge	-	-	-	-	-	-	1 kV	2 kV	0.5kV
Industrial Certification	-	-	-	C1D2, ATEX, IECEx	C1D2, ATEX/IECEx	-	C1D2, ATEX/IECEx	-	C1D2, ATEX, IECEx



Find out more at [www.moxa.com/MediaConverter](http://www.moxa.com/MediaConverter)

# Choose a Protocol Gateway



The MGate fieldbus-to-Ethernet gateways connect your serial devices to an Ethernet network and convert between various industrial protocols, such as Modbus TCP, EtherNet/IP, and other energy industry protocols. Take a quick glimpse of our offerings below or scan the QR code for the comprehensive selection guide.



### Easy to Use

Intuitive web interface and streamlined functionality ensure seamless configuration, issue diagnostics, and troubleshooting



### Better Performance

Experience seamless operations with better data transfer, reliable remote access, and effortless management, while reducing expenses and workforce requirements



### Reliable Protection

Industrial rugged design, secure firmware, and cybersecurity features provide cost and labor savings, and peace of mind against physical and network threats



Device A/B	Modbus RTU/ASCII	PROFIBUS	J1939/CANopen	DNP3 Serial	IEC 101	Modbus TCP	EtherNet/IP	PROFINET	DNP3 TCP	IEC 104	BACnet/IP	IEC 61850 MMS
Modbus RTU/ASCII	1) MB3000	4101/5111	2)5118/5121			MB3000/5105/5109	5105/5135/5435	5103/5134	5109		5217	5119
PROFIBUS		4101/5111				5101/5111	5111	5102/5111				
J1939/CANopen			2)5118/5121			2)5118/5121	2)5118/5122	2)5118/5123				
DNP3 Serial						5109			5109	5114		5119
IEC 101						5114				5114		5119
Modbus TCP	MB3000/5105/5109	5101/5111	2)5118/5121	5109	5114	5109	5105/5135/5435	5103/5134	5109	5114	5217	5119
EtherNet/IP		5111	2)5118/5122			5105/5135/5435		5103				
PROFINET		5102/5111	2)5118/5123			5103/5134	5103					
DNP3 TCP				5109		5109						5119
IEC 104				5114	5114	5114						5119
BACnet/IP												
IEC 61850 MMS		5119		5119	5119	5119			5119	5119		

1) Applies only to the MB3270/3660  
 2) Applies only to J1939



See the complete product line at [www.moxa.com/MGate](http://www.moxa.com/MGate)



# Choose a USB-to-serial Converter/USB Hub

Connect your ATMs, kiosks, POS stations, and data-acquisition applications in harsh environments. Moxa's UPort series of USB-to-serial converters provides Hi-Speed USB 2.0 speeds up to 480 Mbps, and our USB hubs provide Super-Speed USB 3.0 speeds up to 5 Gbps.

Product Type	USB Interface	USB Interface		
		USB 1.1	USB 2.0	USB 3.2
USB Hub	4 Ports	-	UPort 204/UPort 404*	UPort 204A/UPort 404A*
	7 Ports	-	UPort 207/UPort 407*	UPort 207A/UPort 407A*
RS-232 Converter	1 Port	UPort 1110	-	-
	2 Ports	-	UPort 2210	-
	4 Ports	-	UPort 1410/UPort 2410	-
	8 Ports	-	UPort 1610-8	-
	16 Ports	-	UPort 1610-16	-
RS-422/485 Converter	1 Port	UPort 1130	-	-
RS-232/422/485 Converter	1 Port	UPort 1150	-	-
	2 Ports	-	UPort 1250	-
	4 Ports	-	UPort 1450	-
	8 Ports	-	UPort 1650-8	-
	16 Ports	-	UPort 1650-16	-

\*The UPort 400/400A Series comprises industrial models with protection & wide-temperature design

# Choose a Multiport Serial Board



With over thirty years of experience in multiport serial board technology and development, Moxa can offer one of the most comprehensive selections of industrial-grade multiport serial cards on the market. We offer serial boards for a variety of slot types, from PCI, PCI Express (PCIe), PC/104 to mini-PCIe.

Serial Type & Port No.	Host Interface	Host Interface				
		mini-PCIe	PCIe	UPCI/PCI	PC/104	PC/104 plus
RS-232	2 Ports	CP-102N	CP-102E/CP-102EL*	CP-102U/CP-102UL	-	-
	4 Ports	CP-104N	CP-104EL-A	CP-104UL/ CP-104JU**/ POS-104UL***	CA-104	-
	8 Ports	-	CP-168EL-A	CP-168U	CA-108	CB-108
RS-422/485	2 Ports	CP-132N	CP-132EL	CP-132UL	CA-132	-
	4 Ports	CP-134N	CP-134EL-A	CP-134U	CB-134	CB-134
	8 Ports	-	CP-138E-A	CP-138U	-	-
RS-232/422/485	2 Ports	-	-	CP-112UL	-	-
	4 Ports	CP-114N	CP-114EL	CP-114UL	CA-114	CB-114
	8 Ports	-	CP-118E-A/ CP-118EL-A	CP-118U	-	-
	16 Ports	-	CP-116E-A	-	-	-
CANbus	2 Ports	-	CP-602E	CP-602U	-	CB-602

\*EL/UL refers to profile design (half-height card)  
 \*\*JU refers to 8-pin RJ45 serial connector models  
 \*\*\*POS refers to power-over-serial models

Note: Serial isolation applies to only some models



See the complete product line at  
[www.moxa.com/MSB](http://www.moxa.com/MSB)



See the complete product line at  
[www.moxa.com/UPort](http://www.moxa.com/UPort)

# Choose a Remote I/O Product

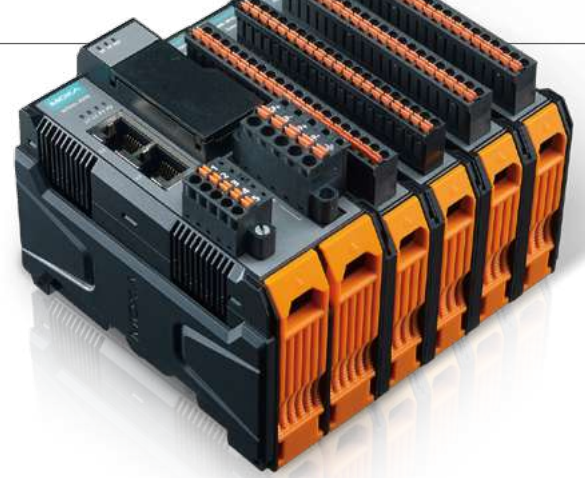

Moxa provides a wide range of remote I/O products for industrial automation in factories, energy and transportation applications, and city infrastructure



### Multiple Protocol Support

Supports various IT protocols and Modbus TCP protocol for easier deployment in different applications

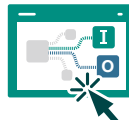

### Easy Configuration and Deployment

Supports a built-in web interface for quick configuration and an utility for mass deployment



### Wide Selection

Compact standalone and modular I/O solutions for versatile data acquisition applications

## ioThinX 4510 Series and Modules



### Features

- Expansion Modules: 32
- IT Protocols: SNMPv1/v2c/v3, SNMPv1/v2c/v3 Trap, SNMPv2c/v3 Inform, RESTful API
- OT Protocol: Modbus TCP Server (slave)
- Gateway Function: Modbus RTU Master to Modbus TCP, SNMP, RESTful API
- Operating Temperature: Standard Models: -20 to 60°C; Wide Temp. Models: -40 to 75°C

Module	45MR-1600	45MR-1601	45MR-2600	45MR-2601	45MR-2606	45MR-2404	45MR-3800	45MR-3810	45MR-4420	45MR-6600	45MR-6810
Digital Inputs	16 (PNP)	16 (NPN)	-	-	8 (PNP)	-	-	-	-	-	-
Digital Outputs	-	-	16 (sink)	16 (source)	8 (source)	-	-	-	-	-	-
Relays	-	-	-	-	-	4 (N.O.)	-	-	-	-	-
Analog Inputs	-	-	-	-	-	-	8 (0/4-20 mA)	8 (-10/0-10 V)	-	-	-
Analog Outputs	-	-	-	-	-	-	-	-	4 (0/4-20 mA, 0-10 V)	-	-
RTDs	-	-	-	-	-	-	-	-	-	6	-
Thermocouples	-	-	-	-	-	-	-	-	-	-	8

## ioLogik E1200 Series



### Features

- 2-port Ethernet switch for daisy-chain topologies
- Saves time and wiring costs with peer-to-peer communications
- Class I Division 2, ATEX Zone 2 certification

Model	E1210	E1211	E1212	E1213	E1214	E1240	E1241	E1242	E1260	E1262
Inputs/Outputs	16 DI	16 DO	8 DI, 8 DIO	8 DI, 4 DO, 4 DIO	6 DI, 6 Relay	8 AI	4 AO	4 AI, 4 DI, 4 DIO	6 RTD	8 TC
Operating Temperature	Standard models: -10 to 60°C; Wide temp. models: -40 to 75°C									
Communication Protocols	Modbus TCP, EtherNet/IP, SNMPv1/v2c, RESTful API									



See the complete product line at [www.moxa.com/RemoteIO](http://www.moxa.com/RemoteIO)



## Pioneering Reliability Since 1987

35 years of a field-proven, reliable,  
and secure connectivity track record



[www.moxa.com/TSP](http://www.moxa.com/TSP)



## Your Trusted Partner in Automation

Moxa is a leading provider of edge connectivity, industrial computing, and network infrastructure solutions for enabling connectivity for the Industrial Internet of Things (IIoT). With 35 years of industry experience, Moxa has connected more than 94 million devices worldwide and has a distribution and service network that reaches customers in more than 85 countries. Moxa delivers lasting business value by empowering industries with reliable networks and sincere service. Information about Moxa's solutions is available at [www.moxa.com](http://www.moxa.com).

### Moxa Americas USA

Toll Free: 1-888-MOXA-USA  
Tel: +1-714-528-6777  
Fax: +1-714-528-6778  
[usa@moxa.com](mailto:usa@moxa.com)

### Brazil

Tel: +55-11-95261-6545  
[brazil@moxa.com](mailto:brazil@moxa.com)

### Moxa Europe

Tel: +49-89-413-25-73-0  
[europe@moxa.com](mailto:europe@moxa.com)

### Moxa Asia-Pacific and Taiwan Asia/Taiwan

Tel: +886-2-8919-1230  
Fax: +886-2-8522-8623  
[asia@moxa.com](mailto:asia@moxa.com)  
[taiwan@moxa.com](mailto:taiwan@moxa.com)

### India

Tel: +91-80-4172-9088  
Fax: +91-80-4132-1045  
[india@moxa.com](mailto:india@moxa.com)

### Russia

Tel: +7-495-287-0929  
Fax: +7-495-269-0929  
[russia@moxa.com](mailto:russia@moxa.com)

### Korea

Tel: +82-2-6268-4048  
Fax: +82-2-6268-4044  
[korea@moxa.com](mailto:korea@moxa.com)

### Japan

Tel: +81-3-6721-5670  
Fax: +81-3-6721-5671  
[japan@moxa.com](mailto:japan@moxa.com)

### Moxa China Shanghai

Tel: +86-21-5258-9955  
Fax: +86-21-5258-5505  
[china@moxa.com](mailto:china@moxa.com)

### Beijing

Tel: +86-10-5976-6123/24/25/26  
Fax: +86-10-5976-6122  
[china@moxa.com](mailto:china@moxa.com)

### Shenzhen

Tel: +86-755-8368-4084/94  
Fax: +86-755-8368-4148  
[china@moxa.com](mailto:china@moxa.com)